

Industrial Ethernet Switch - FL SWITCH 3004T-FX ST



2891034

<https://www.phoenixcontact.com/us/products/2891034>

Please be informed that the data shown in this PDF document is generated from our Online Catalog. Please find the complete data in the user documentation. Our General Terms of Use for Downloads are valid.



Managed Ethernet switch with four RJ45 ports at 10/100 Mbps, one ST format fiber optic port and operating temperature of -40°C ... +75°C

Product Description

FL SWITCH 3000 managed industrial Ethernet switches combine extensive network performance and security features with complete IEEE redundancy (STP/RSTP/MST) and 15 ms recovery time extended ring redundancy. Unique web customization provides a simplified user interface for today's applications and scalable functionality for future needs. A comprehensive mix of fiber optic and copper port connections meets a wide range of applications.

Your advantages

- RJ45 ports support a transmission speed of 10/100 Mbps
- Fiber-optic ports support 100 Mbps
- -40 to 75°C and -10 to 60°C ambient temperature versions
- Secure web-based and SNMP-based management
- Security options with cable locking
- Extensive web diagnostics with configurable LED and remote alarm contacts
- Unique cleanup function hides unused configuration pages, reducing complexity, maintenance and startup times
- Auto negotiation and autocrossing detection simplifies installation and setup

Commercial Data

Item number	2891034
Packing unit	1 pc
Minimum order quantity	1 pc
Note	Made to Order (non-returnable)
Sales Key	C23
Product Key	DNN125
Catalog Page	Page 315 (C-6-2019)
GTIN	4046356659154
Weight per Piece (including packing)	1,023 g
Weight per Piece (excluding packing)	930 g
Customs tariff number	85176200
Country of origin	TW

Technical Data

Dimensions

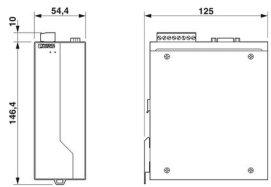
Dimensional drawing	
Width	54.4 mm
Height	146.4 mm
Depth	125 mm

Notes

Utilization restriction

EMC note	EMC: class A product, see manufacturer's declaration in the download area
----------	---

Utilization restriction

CCCex note	Use in potentially explosive areas is not permitted in China.
------------	---

Material specifications

Housing material	Aluminum
------------------	----------

Mounting

Mounting type	DIN rail mounting
---------------	-------------------

Interfaces

Ethernet (RJ45)

Connection method	RJ45
Note on the connection method	Auto negotiation and autocrossing
Transmission speed	10/100 Mbps
Transmission physics	Ethernet in RJ45 twisted pair
No. of channels	4 (RJ45 ports)

Fiber optic interface

Connection method	ST
Transmission speed	100 Mbps (full duplex)
Transmission physics	multi-mode fiberglass
Transmission length	12.1 km (fiberglass with F-G 62.5/125 0.7 dB/km F1000)
	3.3 km (fiberglass with F-G 62.5/125 2.6 dB/km F600)
	7.1 km (fiberglass with F-G 50/125 0.7 dB/km F1200)
	3.1 km (fiberglass with F-G 50/125 1.6 dB/km F800)
Wavelength	1300 nm

Industrial Ethernet Switch - FL SWITCH 3004T-FX ST



2891034

<https://www.phoenixcontact.com/us/products/2891034>

No. of channels	1 (ST multi-mode)
-----------------	-------------------

Product properties

Type	Block design
Product type	Switch

Insulation characteristics

Protection class	III (VDE 0106, IEC 60536)
------------------	---------------------------

Switch functions

Basic functions	Store and forward switch, Extended Ring and IEEE redundancy, Multicast control, IGMP snooping, trunking, Port and Tagging VLANs, Port and IEEE 802.1x security, SNMP V3 and Https security, SNTP, web customization, user accounts
Signal contact control voltage	24 V DC
Signal contact control current	100 mA
Redundancy	ERR (Extended ring redundancy)
Status and diagnostic indicators	LEDs: U _{S1} , U _{S2} (redundant voltage supply), link and activity per port

Security functions

Basic functions	Store and forward switch, Extended Ring and IEEE redundancy, Multicast control, IGMP snooping, trunking, Port and Tagging VLANs, Port and IEEE 802.1x security, SNMP V3 and Https security, SNTP, web customization, user accounts
-----------------	--

Electrical properties

Local diagnostics	US1, US2 Supply voltage Green LED
	LNK/ACT Link status/data transmission Green LED
	100 Data transmission speed Red LED
Maximum power dissipation for nominal condition	5.5 W
Test section	Supply voltage/functional ground 500 V 1 min.
Transmission medium	Copper
	FO

Supply

Supply voltage	24 V DC (redundant)
Supply voltage range	12 V DC ... 48 V DC
Inrush current	4.76 A (3.1 ms)
Residual ripple	3.6 V _{PP} (within the permitted voltage range)
Typical current consumption	217 mA (at U _S = 24 V DC)

Function

Signal contact control voltage	24 V DC
Signal contact control current	100 mA

Connection data

Connection technology

Connection name	Power supply
-----------------	--------------

Power supply

Connection method	Pluggable COMBICON screw connections
Conductor cross section, rigid	0.2 mm ² ... 2.5 mm ²
Stripping length	7 mm

Ambient conditions

Degree of protection	IP20
Ambient temperature (operation)	-40 °C ... 75 °C
Ambient temperature (storage/transport)	-40 °C ... 85 °C
Permissible humidity (operation)	5 % ... 95 % (non-condensing)
Permissible humidity (storage/transport)	5 % ... 95 % (non-condensing)
Air pressure (operation)	57 kPa ... 108 kPa (up to 4850 m above mean sea level)
Air pressure (storage/transport)	57 kPa ... 108 kPa (up to 4850 m above mean sea level)

Approval data

Conformity/Approvals

Conformance	CE-compliant
ATEX	<input type="checkbox"/> II 3 G Ex nA nC IIC T4 Gc
EU-type examination certificate	DEMKO 16 ATEX 1616X
IECEX	Ex nA nC IIC T4 Gc
IECEX certificate	IECEX UL 16.0094X
UL, USA / Canada	Class I, Div. 2, Groups A, B, C, D

EMC data

Conformance with EMC directives	IEC 61000-6-2 IEC 61000-4-2 (ESD) Criterion B
	IEC 61000-4-3 (immunity to radiated interference) Criterion A
	IEC 61000-4-4 (burst) Criterion A
	IEC 61000-4-5 (surge) Criterion B
	IEC 61000-4-6 (immunity to conducted interference) Criterion A
	IEC 61000-4-8 (immunity to magnetic fields) Criterion A
	EN 55022 (emitted interference) Class A
	NEMA TS-2
Noise emission	EN 61000-6-4
Noise immunity	EN 61000-6-2:2005

LED signaling

Status display	LEDs: U _{S1} , U _{S2} (redundant voltage supply), link and activity per port
----------------	--

Industrial Ethernet Switch - FL SWITCH 3004T-FX ST



2891034

<https://www.phoenixcontact.com/us/products/2891034>

Drawings

Dimensional drawing

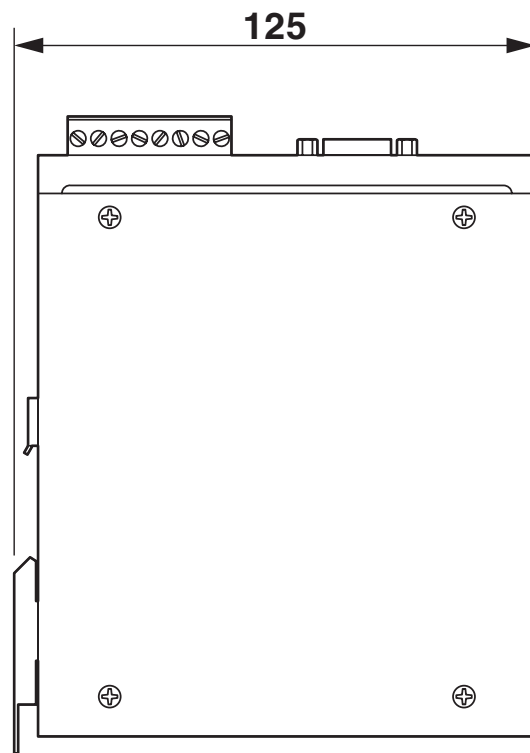
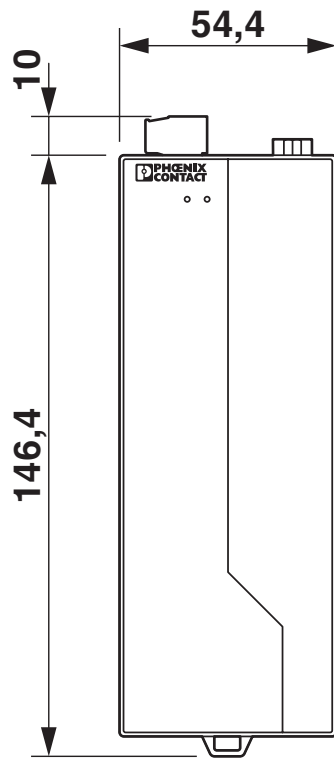

2891034

<https://www.phoenixcontact.com/us/products/2891034>

Classifications

ECLASS

ECLASS-9.0	19170106
ECLASS-10.0.1	19170401
ECLASS-11.0	19170401

ETIM

ETIM 7.0	EC000734
----------	----------

2891034

<https://www.phoenixcontact.com/us/products/2891034>

Environmental Product Compliance

REACH SVHC	Lead 7439-92-1
China RoHS	Environmentally Friendly Use Period = 10; For information on hazardous substances, refer to the manufacturer's declaration available under "Downloads"

2891034

<https://www.phoenixcontact.com/us/products/2891034>

Accessories

PCB connector

PCB connector - MSTB 2,5/ 8-ST - 1754562

<https://www.phoenixcontact.com/us/products/1754562>



PCB connector, nominal cross section: 2.5 mm², color: green, nominal current: 12 A, rated voltage (III/2): 320 V, contact surface: Tin, type of contact: Female connector, number of potentials: 8, number of rows: 1, number of positions: 8, number of connections: 8, product range: MSTB 2,5/...-ST, pitch: 5 mm, connection method: Screw connection with tension sleeve, screw head form: L Slotted, conductor/PCB connection direction: 0 °, locking clip: - Locking clip, plug-in system: COMBICON MSTB 2,5, locking: without, mounting: without, type of packaging: packed in cardboard

Port Guard Security Element

Port Guard Security Element - FL PATCH GUARD - 2891424

<https://www.phoenixcontact.com/us/products/2891424>



Lockable security element

2891034

<https://www.phoenixcontact.com/us/products/2891034>

Key

Key - FL PATCH GUARD KEY - 2891521

<https://www.phoenixcontact.com/us/products/2891521>

Key for lockable security element



Surge protection device

Surge protection device - DT-LAN-CAT.6+ - 2881007

<https://www.phoenixcontact.com/us/products/2881007>



Surge protection in accordance with Class E_A (CAT6_A), for Gigabit Ethernet (up to 10 Gbps), token ring, FDDI/CDDI, ISDN, and DS1. Suitable for Power over Ethernet (PoE++ / 4PPoE) "Mode A" and "Mode B". RJ45 attachment plug with separate grounding cable and ground connection snap-on foot for NS 35 DIN rails.

Industrial Ethernet Switch - FL SWITCH 3004T-FX ST



2891034

<https://www.phoenixcontact.com/us/products/2891034>

Port Guard Security Element

Port Guard Security Element - FL SEC PAC 4TX - 2832865

<https://www.phoenixcontact.com/us/products/2832865>

Layer1 security elements for four RJ45 network connections for use with patch boxes and panels



DIN rail adapter

DIN rail adapter - FL DIN RA - 2891053

<https://www.phoenixcontact.com/us/products/2891053>

The FL DIN RA is installed in a standard, 19-inch rack (EIA-310-D, IEC 60297-3-100) to allow DIN rail mounted equipment to be rack mounted.



2891034

<https://www.phoenixcontact.com/us/products/2891034>

Dust protection

Dust protection - FL RJ45 PROTECT CAP - 2832991

<https://www.phoenixcontact.com/us/products/2832991>

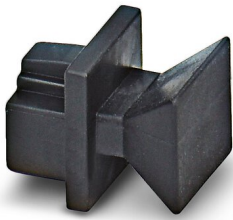

Dust protection caps for RJ45 socket

End clamp

End clamp - E/NS 35 N - 0800886

<https://www.phoenixcontact.com/us/products/0800886>

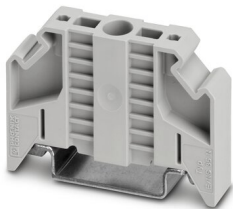

End clamp, width: 9.5 mm, color: gray

2891034

<https://www.phoenixcontact.com/us/products/2891034>

Patch cable

Patch cable - FL CAT5 PATCH 0,5 - 2832263

<https://www.phoenixcontact.com/us/products/2832263>

Patch cable, CAT5, assembled, 0.5 m



Patch cable

Patch cable - FL CAT5 PATCH 1,0 - 2832276

<https://www.phoenixcontact.com/us/products/2832276>

Patch cable, CAT5, assembled, 1 m



Industrial Ethernet Switch - FL SWITCH 3004T-FX ST



2891034

<https://www.phoenixcontact.com/us/products/2891034>

Patch cable

Patch cable - FL CAT5 PATCH 2,0 - 2832289

<https://www.phoenixcontact.com/us/products/2832289>

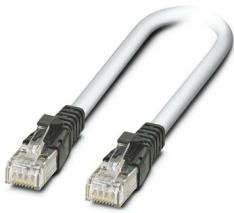

Patch cable, CAT5, assembled, 2 m

Patch cable

Patch cable - NBC-R4AC-R4AC-IE8A/.../... - 1411854

<https://www.phoenixcontact.com/us/products/1411854>

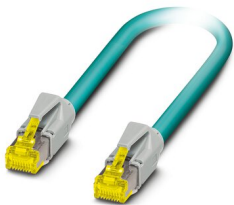

Patch cable, degree of protection: IP20, number of positions: 8, 10 Gbps, CAT6_A, cable outlet: straight, Ethernet

2891034

<https://www.phoenixcontact.com/us/products/2891034>

Patch cable

Patch cable - NBC-R4AC/10G-R4AC/10G-94F/2,0 - 1408360

<https://www.phoenixcontact.com/us/products/1408360>

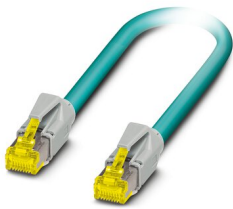

Patch cable, CAT6_A, 4-pair, shielded, connection not crossed (line), assembled at both ends with RJ45/IP20 connectors, outer sheath material: PUR, length: 2.0 m

Patch cable

Patch cable - NBC-R4AC/10G-R4AC/10G-94F/3,0 - 1408365

<https://www.phoenixcontact.com/us/products/1408365>

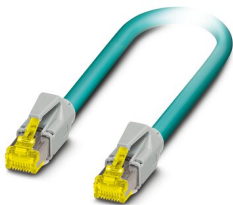

Patch cable, CAT6_A, 4-pair, shielded, connection not crossed (line), assembled at both ends with RJ45/IP20 connectors, outer sheath material: PUR, length: 3.0 m

Industrial Ethernet Switch - FL SWITCH 3004T-FX ST



2891034

<https://www.phoenixcontact.com/us/products/2891034>

Patch cable

Patch cable - NBC-R4AC/1,0-93B/R4AC - 1408968

<https://www.phoenixcontact.com/us/products/1408968>



Patch cable, degree of protection: IP20, cable length: 1 m, number of positions: 4, 100 Mbps, CAT5, material: PA 6.6, PROFINET

Patch cable

Patch cable - NBC-R4AC/2,0-93B/R4AC - 1408969

<https://www.phoenixcontact.com/us/products/1408969>



Patch cable, degree of protection: IP20, cable length: 2 m, number of positions: 4, 100 Mbps, CAT5, material: PA 6.6, PROFINET

2891034

<https://www.phoenixcontact.com/us/products/2891034>

Patch cable

Patch cable - NBC-R4AC/5,0-93B/R4AC - 1408970

<https://www.phoenixcontact.com/us/products/1408970>



Patch cable, degree of protection: IP20, cable length: 5 m, number of positions: 4, 100 Mbps, CAT5, material: PA 6.6, PROFINET

FO patch cable

FO patch cable - FOC-ST:PA-SC:PA-OM2:D01/1 - 1115574

<https://www.phoenixcontact.com/us/products/1115574>

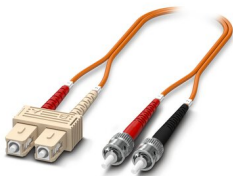

Multi-mode OM2 duplex jumper, ST-SC, UPC polishing, length 1 m

Industrial Ethernet Switch - FL SWITCH 3004T-FX ST



2891034

<https://www.phoenixcontact.com/us/products/2891034>

FO patch cable

FO patch cable - FOC-ST:PA-SC:PA-OM2:D01/2 - 1115573

<https://www.phoenixcontact.com/us/products/1115573>

Multi-mode OM2 duplex jumper, ST-SC, UPC polishing, length 2 m

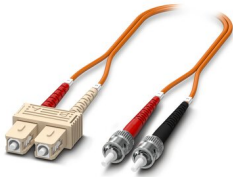

FO patch cable

FO patch cable - FOC-ST:PA-ST:PA-OM2:D01/1 - 1115560

<https://www.phoenixcontact.com/us/products/1115560>

Multi-mode OM2 duplex jumper, ST-ST, UPC polishing, length 1 m



2891034

<https://www.phoenixcontact.com/us/products/2891034>

FO patch cable

FO patch cable - FOC-ST:PA-ST:PA-OM2:D01/2 - 1115557

<https://www.phoenixcontact.com/us/products/1115557>

Multi-mode OM2 duplex jumper, ST-ST, UPC polishing, length 2 m



Fiber optic cable

Fiber optic cable - FOC-LC:PA-ST:PA-OM2:D01/1 - 1115588

<https://www.phoenixcontact.com/us/products/1115588>

Multi-mode OM2 duplex jumper, LC-ST, UPC polishing, length 1 m

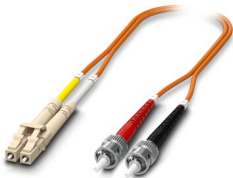

Industrial Ethernet Switch - FL SWITCH 3004T-FX ST



2891034

<https://www.phoenixcontact.com/us/products/2891034>

Fiber optic cable

Fiber optic cable - FOC-LC:PA-ST:PA-OM2:D01/2 - 1115587

<https://www.phoenixcontact.com/us/products/1115587>

Multi-mode OM2 duplex jumper, LC-ST, UPC polishing, length 2 m

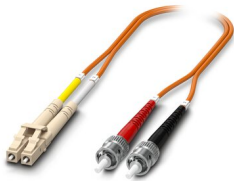

Phoenix Contact 2022 © - all rights reserved

<https://www.phoenixcontact.com>

Phoenix Contact USA
586 Fulling Mill Road
Middletown, PA 17057, United States
(+717) 944-1300
info@phoenixcon.com